

40V MATCHED PAIR PNP SMALL SIGNAL TRANSISTOR IN SOT363
Features

- $BV_{CEO} > -40V$
- $I_C = -200mA$ High Collector Current
- Pair of PNP Transistors That Are Intrinsically Matched (Note 1)
- 2% Matching on Current Gain (h_{FE})
- 2mV Matching on Base-Emitter Voltage (V_{BE})
- Fully Internally Isolated in a Small Surface Mount Package
- **Totally Lead-Free & Fully RoHS Compliant (Notes 2 & 3)**
- **Halogen and Antimony Free. "Green" Device (Note 4)**
- **Qualified to AEC-Q101 Standards for High Reliability**
- **PPAP Capable (Note 5)**

Mechanical Data

- Case: SOT363
- Case Material: Molded Plastic, "Green" Molding Compound. UL Flammability Classification Rating 94V-0
- Moisture Sensitivity: Level 1 per J-STD-020
- Terminals: Finish — Matte Tin Finish. Solderable per MIL-STD-202, Method 208 (3)
- Weight: 0.006 grams (approximate)

Applications

- Current Mirrors
- Differential and Instrumentation Amplifiers
- Comparators



Top View

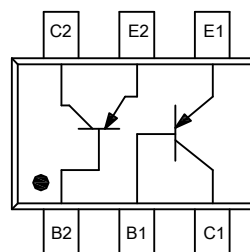

Device Schematic and Pin-Out Top View

Ordering Information (Note 4 & 5)

Part Number	Compliance	Marking	Reel Size (inches)	Tape Width (mm)	Quantity per Reel
DMMT3906W-7-F	AEC-Q101	K4B	7	8	3,000
DMMT3906WQ-7-F	Automotive	K4B	7	8	3,000

- Notes:
1. Intrinsically matched pair as this is built with adjacent die from the same wafer.
 2. No purposely added lead. Fully EU Directive 2002/95/EC (RoHS) & 2011/65/EU (RoHS 2) compliant.
 3. See http://www.diodes.com/quality/lead_free.html for more information about Diodes Incorporated's definitions of Halogen- and Antimony-free, "Green" and Lead-free.
 4. Halogen- and Antimony-free "Green" products are defined as those which contain <900ppm bromine, <900ppm chlorine (<1500ppm total Br + Cl) and <1000ppm antimony compounds.
 5. Automotive products are AEC-Q101 qualified and are PPAP capable. Automotive, AEC-Q101 and standard products are electrically and thermally the same, except where specified. For more information, please refer to http://www.diodes.com/quality/product_compliance_definitions/.
 6. For packaging details, go to our website at <http://www.diodes.com/products/packages.html>.

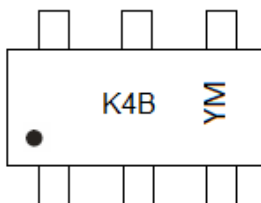
Marking Information

K4B = Product Type Marking Code
 YM = Date Code Marking
 Y = Year (ex: B = 2014)
 M = Month (ex: 2 = February)

Date Code Key

Year	2010	2011	2012	2013	2014	2015	2016	2017
Code	X	Y	Z	A	B	C	D	E

Month	Jan	Feb	Mar	Apr	May	Jun	Jul	Aug	Sep	Oct	Nov	Dec
Code	1	2	3	4	5	6	7	8	9	O	N	D

Absolute Maximum Ratings (@ $T_A = +25^\circ\text{C}$ unless otherwise specified.)

Characteristic	Symbol	Value	Unit
Collector-Base Voltage	V_{CB0}	-40	V
Collector-Emitter Voltage	V_{CEO}	-40	V
Emitter-Base Voltage	V_{EB0}	-5.0	V
Collector Current	I_C	-200	mA

Thermal Characteristics – Total Device (@ $T_A = +25^\circ\text{C}$ unless otherwise specified.)

Characteristic	Symbol	Value	Unit
Power Dissipation (Note 7) Total Device	P_D	200	mW
Thermal Resistance, Junction to Ambient (Note 7)	$R_{\theta JA}$	625	$^\circ\text{C/W}$
Operating and Storage Temperature Range	T_J, T_{STG}	-65 to +150	$^\circ\text{C}$

ESD Ratings (Note 8)

Characteristic	Symbol	Value	Unit	JEDEC Class
Electrostatic Discharge - Human Body Model	ESD HBM	4,000	V	3A
Electrostatic Discharge - Machine Model	ESD MM	400	V	C

- Note:
- For a device mounted on minimum recommended pad layout with 1oz copper that is on a single-sided 1.6mm FR4 PCB; the device is measured under still air conditions whilst operating in a steady-state.
 - Refer to JEDEC specification JESD22-A114 and JESD22-A115.

Thermal Characteristics – Total Device

Fig. 1, Power Derating Curve (Total Device)

Electrical Characteristics (@T_A = +25°C unless otherwise specified)

Characteristic	Symbol	Min	TYP	Max	Unit	Test Condition
OFF CHARACTERISTICS						
Collector-Base Breakdown Voltage	BV _{CBO}	-40	—	—	V	I _C = -100μA, I _E = 0
Collector-Emitter Breakdown Voltage (Note 9)	BV _{CEO}	-40	—	—	V	I _C = -1.0mA, I _B = 0
Emitter-Base Breakdown Voltage	BV _{EBO}	-5.0	—	—	V	I _E = -100μA, I _C = 0
Collector Cutoff Current	I _{CEX}	—	—	-50	nA	V _{CE} = -30V, V _{EB(OFF)} = 3.0V
Base Cutoff Current	I _{BL}	—	—	-50	nA	V _{CE} = -30V, V _{EB(OFF)} = 3.0V
ON CHARACTERISTICS (Note 9)						
DC Current Gain	h _{FE}	60 80 100 60 30	—	— — 300 — —	—	I _C = -100μA, V _{CE} = -1.0V I _C = -1.0mA, V _{CE} = -1.0V I _C = -10mA, V _{CE} = -1.0V I _C = -50mA, V _{CE} = -1.0V I _C = -100mA, V _{CE} = -1.0V
Collector-Emitter Saturation Voltage	V _{CE(SAT)}	—	—	-250 -400	mV	I _C = -10mA, I _B = -1.0mA I _C = -50mA, I _B = -5.0mA
Base-Emitter Saturation Voltage	V _{BE(SAT)}	0.65 —	—	-850 -950	mV	I _C = -10mA, I _B = -1.0mA I _C = -50mA, I _B = -5.0mA
MATCHING CHARACTERISTICS						
DC Current Gain Matching (Note 10)	h _{FE1} / h _{FE2}	—	1	2	%	I _C = -2mA, V _{CE} = -5V
Base-Emitter Voltage Matching (Note 11)	V _{BE1} - V _{BE2}	—	1	2	mV	I _C = -2mA, V _{CE} = -5V
Collector-Emitter Saturation Voltage (Note 10)	V _{CE(SAT)1} / V _{CE(SAT)2}	—	1	2	%	I _C = -10mA, I _B = -1.0mA
Base-Emitter Saturation Voltage (Note 10)	V _{BE(SAT)1} / V _{BE(SAT)2}	—	1	2	%	I _C = -10mA, I _B = -1.0mA
SMALL SIGNAL CHARACTERISTICS						
Output Capacitance	C _{obo}	—	—	4.5	pF	V _{CB} = -5.0V, f = 1.0MHz, I _E = 0
Input Capacitance	C _{ibo}	—	—	10.0	pF	V _{EB} = -0.5V, f = 1.0MHz, I _C = 0
Input Impedance	h _{ie}	2.0	—	12	kΩ	V _{CE} = 10V, I _C = 1.0mA, f = 1.0kHz
Voltage Feedback Ratio	h _{re}	0.1	—	10	x 10 ⁻⁴	
Small Signal Current Gain	h _{fe}	100	—	400	—	
Output Admittance	h _{oe}	3.0	—	60	μS	
Current Gain-Bandwidth Product	f _T	250	—	—	MHz	V _{CE} = -20V, I _C = -10mA, f = 100MHz
Noise Figure	NF	—	—	4.0	dB	V _{CE} = -5.0V, I _C = -100μA, R _S = 1.0kΩ, f = 1.0kHz
SWITCHING CHARACTERISTICS						
Delay Time	t _d	—	—	35	ns	V _{CC} = -3.0V, I _C = -10mA, V _{BE(off)} = 0.5V, I _{B1} = -1.0mA
Rise Time	t _r	—	—	35	ns	
Storage Time	t _s	—	—	225	ns	V _{CC} = -3.0V, I _C = -10mA, I _{B1} = I _{B2} = -1.0mA
Fall Time	t _f	—	—	75	ns	

Note: 9. Measured under pulsed conditions. Pulse width ≤ 300μs. Duty cycle ≤ 2%.
 10. Is the ratio of one transistor compared to the other transistor.
 11. V_{BE1} - V_{BE2} is the absolute difference of one transistor compared to the other transistor.

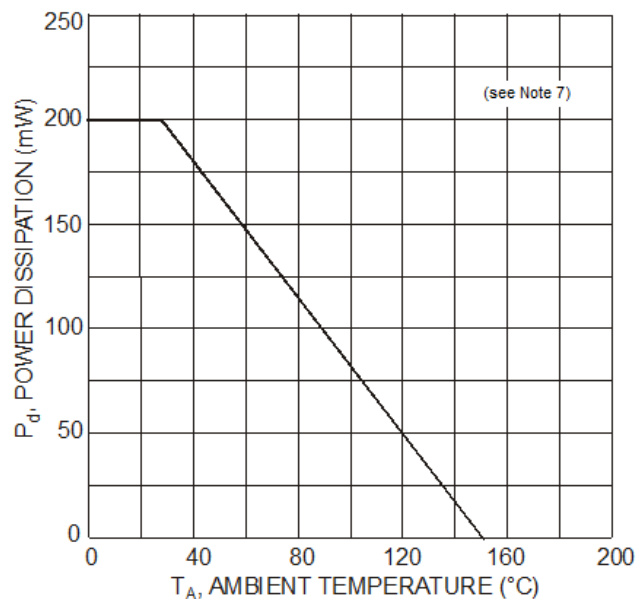
Typical Electrical Characteristics (@ $T_A = +25^\circ\text{C}$ unless otherwise specified.)

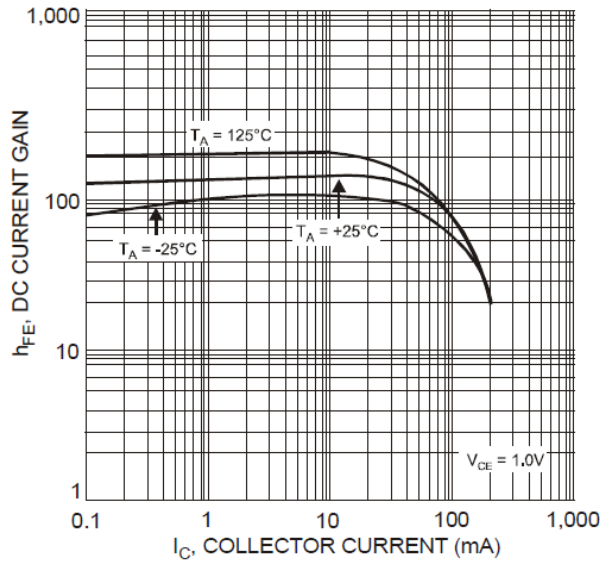

Fig. 3, Typical DC Current Gain vs. Collector Current

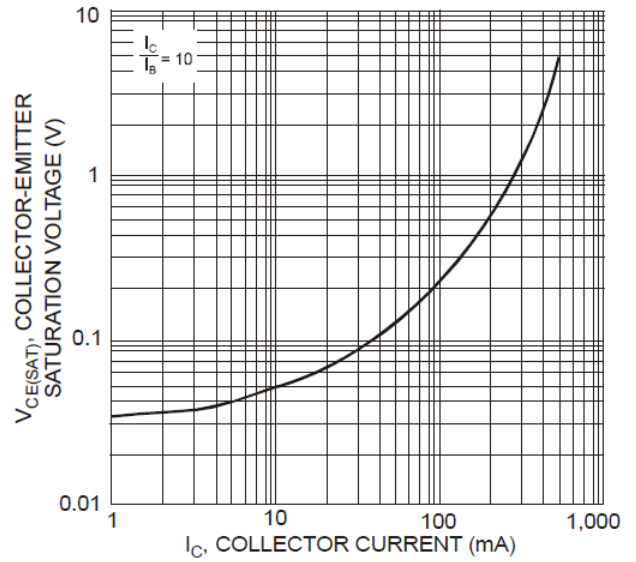

Fig. 4, Typical Collector-Emitter Saturation Voltage vs. Collector Current

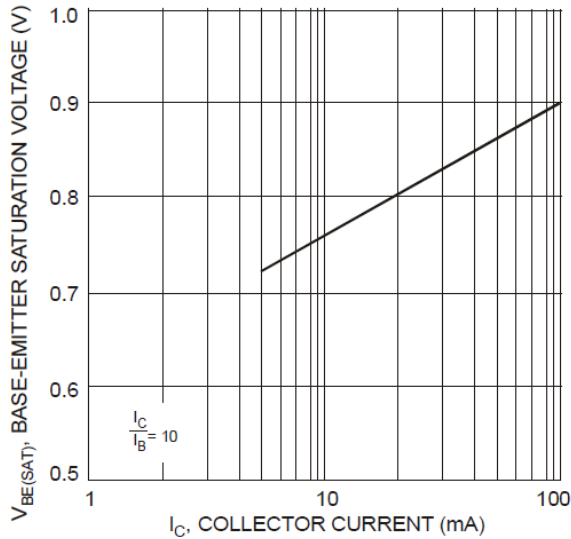

Fig. 5, Typical Base-Emitter Saturation Voltage vs. Collector Current

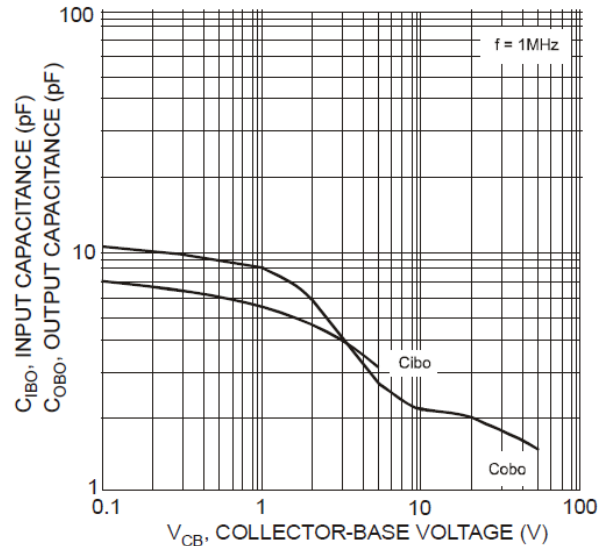
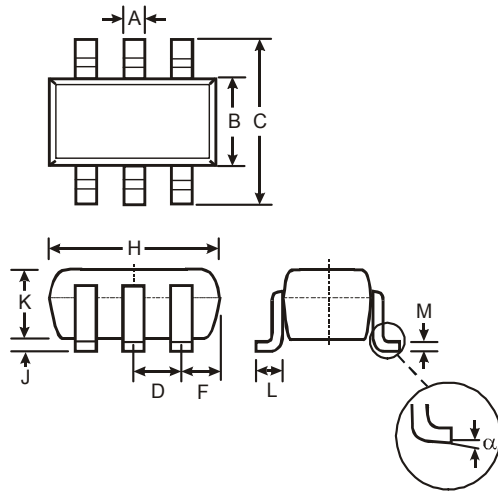

Fig. 2, Input and Output Capacitance vs. Collector-Base Voltage

Package Outline Dimensions

Please see AP02002 at <http://www.diodes.com/datasheets/ap02002.pdf> for latest version.



SOT363			
Dim	Min	Max	Typ
A	0.10	0.30	0.25
B	1.15	1.35	1.30
C	2.00	2.20	2.10
D	0.65 Typ		
F	0.40	0.45	0.425
H	1.80	2.20	2.15
J	0	0.10	0.05
K	0.90	1.00	1.00
L	0.25	0.40	0.30
M	0.10	0.22	0.11
α	0°	8°	-
All Dimensions in mm			

Suggested Pad Layout

Please see AP02001 at <http://www.diodes.com/datasheets/ap02001.pdf> for the latest version.

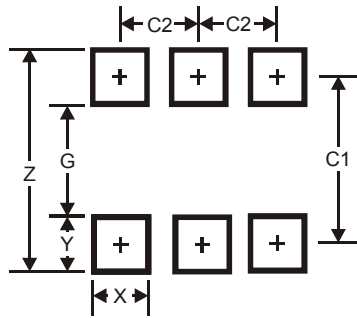

Dimensions	Value (in mm)
Z	2.5
G	1.3
X	0.42
Y	0.6
C1	1.9
C2	0.65

IMPORTANT NOTICE

DIODES INCORPORATED MAKES NO WARRANTY OF ANY KIND, EXPRESS OR IMPLIED, WITH REGARDS TO THIS DOCUMENT, INCLUDING, BUT NOT LIMITED TO, THE IMPLIED WARRANTIES OF MERCHANTABILITY AND FITNESS FOR A PARTICULAR PURPOSE (AND THEIR EQUIVALENTS UNDER THE LAWS OF ANY JURISDICTION).

Diodes Incorporated and its subsidiaries reserve the right to make modifications, enhancements, improvements, corrections or other changes without further notice to this document and any product described herein. Diodes Incorporated does not assume any liability arising out of the application or use of this document or any product described herein; neither does Diodes Incorporated convey any license under its patent or trademark rights, nor the rights of others. Any Customer or user of this document or products described herein in such applications shall assume all risks of such use and will agree to hold Diodes Incorporated and all the companies whose products are represented on Diodes Incorporated website, harmless against all damages.

Diodes Incorporated does not warrant or accept any liability whatsoever in respect of any products purchased through unauthorized sales channel. Should Customers purchase or use Diodes Incorporated products for any unintended or unauthorized application, Customers shall indemnify and hold Diodes Incorporated and its representatives harmless against all claims, damages, expenses, and attorney fees arising out of, directly or indirectly, any claim of personal injury or death associated with such unintended or unauthorized application.

Products described herein may be covered by one or more United States, international or foreign patents pending. Product names and markings noted herein may also be covered by one or more United States, international or foreign trademarks.

This document is written in English but may be translated into multiple languages for reference. Only the English version of this document is the final and determinative format released by Diodes Incorporated.

LIFE SUPPORT

Diodes Incorporated products are specifically not authorized for use as critical components in life support devices or systems without the express written approval of the Chief Executive Officer of Diodes Incorporated. As used herein:

A. Life support devices or systems are devices or systems which:

1. are intended to implant into the body, or
2. support or sustain life and whose failure to perform when properly used in accordance with instructions for use provided in the labeling can be reasonably expected to result in significant injury to the user.

B. A critical component is any component in a life support device or system whose failure to perform can be reasonably expected to cause the failure of the life support device or to affect its safety or effectiveness.

Customers represent that they have all necessary expertise in the safety and regulatory ramifications of their life support devices or systems, and acknowledge and agree that they are solely responsible for all legal, regulatory and safety-related requirements concerning their products and any use of Diodes Incorporated products in such safety-critical, life support devices or systems, notwithstanding any devices- or systems-related information or support that may be provided by Diodes Incorporated. Further, Customers must fully indemnify Diodes Incorporated and its representatives against any damages arising out of the use of Diodes Incorporated products in such safety-critical, life support devices or systems.

Copyright © 2014, Diodes Incorporated

www.diodes.com